

ZL-62x0A+ Temperature Controller Instruction Manual A1.0

Introduction

ZL-62x0A+ series thermostat is for cooling or heating control, with one 30 ampere output, and buzzer beeping and warning function.

Model

Model	Function
ZL-6210A+	Cooling or heating, Warning input
ZL-6220A+	Cooling or heating, Warning input, Periodic defrosting (only in cooling mode)
ZL-6230A+	Cooling or heating, Warning input, Warning output

Main Specification

Power supply: 185~245Vac, 50/60Hz

Sensor: NTC, 1.5 meters long

Output: R1, 30A, 250Vac; R2, 5A, 250Vac

All based on **pure resistance loads**

Setting range: -40~120°C

Display range: -40~130°C

Working: -10~45°C, 5~90%RH without dew

Dimension: W78 x H34.5 x D71 (mm)





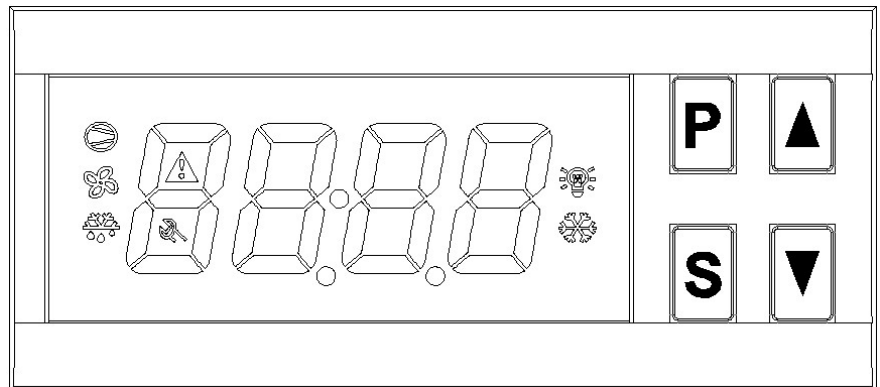

Installation drilling: W71 x H29 (mm)

Case materials: PC + ABS fire proof

Protection level: IP65 (Front side only)



Keypad and Display

Icon	Function	On	Off	Blinking
	Temp. control output(R1)	R1 energized	R1 de-energized	Within protecting delay
	Defrost	Defrosting	Not defrosting now	Dripping water
	Work mode	Cooling mode	Not in cooling mode	Setting set-point
	Work mode	Heating mode	Not in heating mode	Setting set-point
	Maintenance	----	No failure	Has failure
	Warning	----	No warning	Has warning

Display	Remark
E01	Sensor failure (short or open)
Hi	Room temp. is higher than the high limit
Lo	Room temp. is lower than the low limit
EE	Memory error
Err	Password error
iA	External warning
dEF	Defrosting
UnL	Parameters Will restore to factory default settings

Operation

Set Set-Point

Keep [S] depressed for 3 seconds to enter into the status. The current set-point value displays.

Press [▲] or [▼] to set the value (keeping depressed can fast set).

Press [S] to exit, and save the settings.

The status will exit, and the setting will not be saved, if no key operation within 30 seconds.

Set System Parameters

Keep [P] depressed for 3 seconds, digits show "---0".

Press [▼] to select the digit of the password, press [▲] to set the value of the digit.

Press [S] to confirm:

If the password is correct, enter into the parameter setting status, else display “Err”, and exit.

Set in parameter setting status:

Press [▲] or [▼] to select the parameter code (see parameter code table below).

Press [S] to display the value of the code.

Press [▲] or [▼] to set the value.

Press [S] to return to parameter code selection.

Keep [P] depressed for 3 seconds to exit, and save the settings.

The status will exit, and the settings will not be saved, if no key operation for 30 seconds.

Parameter Code Table

Code	Function	Range	Remark	Factory Default	ZL-6210A+	ZL-6220A+	ZL-6230A+
U10	Minimum time for R1 to keep de-energized	0 ~ 100 min		3	•	•	•
U11	Minimum time for R1 to keep energized	0 ~ 100 min		3	•	•	•
U12	Frequency for R1 to be on / off	0 ~ 8	0: disable	5	•	•	•
U20	Sensor calibration	-9.9 ~ +9.9°C		0.0	•	•	•
U22	Hysteresis for temp. control	0.1+10.0°C	U22 < U54, U55	1.0	•	•	•
U30	Defrost period	0 ~ 180 hour	0: never defrost	12		•	
U31	Defrost time	1 ~ 180 min		30		•	
U33	Dripping water time	0 ~ 180 min		5		•	
U34	Over temp. warning delay after defrosted	0 ~ 180 hour	0: disable	2		•	
U35	Defrost after online	0 ~ 1	0: disable / 1: enable	0		•	
U36	Delay for defrost after online	0 ~ 180 min		0		•	
U52	Over temp. warning delay	1 ~ 180 min		30	•	•	•
U53	1 st over temp. warning delay	0 ~ 180 hour	0: disable	2	•	•	•
U54	Hysteresis for high temp. warning	U22 ~ 60.0°C / OFF	OFF (> 60.0°C): disable warning	OFF	•	•	•
U55	Hysteresis for low temp. warning	U22 ~ 60.0°C / OFF	OFF (> 60.0°C): disable warning	OFF	•	•	•
U60	External input warning mode	0 ~ 4	0: disable 1: NO, locked 2: NO, unlocked 3: NC, locked 4: NC, unlocked	0	•	•	•
U61	Delay for external input warning	0 ~ 120 min		0	•	•	•
U62	Buzzing warning	0 ~ 1	0: no warning / 1: enable warning	0	•	•	•
U90	Control mode	CO: cool / HE: heat		CO	•	•	•
U99	Password	0000 ~ 9999	----	1111	•	•	•

Control

● Cooling Control (U90 = C0)

■ Temperature control

If **Troom** ≥ Set-point + U22, and R1 has been de-energized for U10, then R1 energized;

If **Troom** ≤ Set-point - U22, and R1 has been energized for U11, then R1 de-energized.

For example, if set-point = 18, U22 = 0.2, then the controller will control the temperature between 17.8°C and 18.2°C.

■ Forced cooling

Keep [▼] depressed for 5 seconds can force R1 energized under following conditions:

- ◆ R1 has been de-energized for U10;
- ◆ **Troom** is between Set-point + U22 and Set-point - U22;
- ◆ Not in defrosting and dripping water status (only for ZL-6220A+).

The forced energized status will end when **Troom** arrives at Set-point - U22.

■ Stop forced cooling

If now is forced cooling, if R1 has been energized for U11 time, Keep [▼] depress for 5 seconds will stop forced cooling.

● Heating Control (U90 = HE)

■ Temperature control

If **Troom** ≤ Set-point - U22, and R1 has been de-energized for U10, then R1 energized;

If **Troom** ≥ Set-point + U22, and R1 has been energized for U11, then R1 de-energized.

For example, if set-point = 18, U22 = 0.2, then the controller will control the temperature between 17.8°C and 18.2°C.

■ Forced heating

Keep [▼] depressed for 5 seconds can force R1 energized under following conditions:

- ◆ R1 has been de-energized for U10;
- ◆ **Troom** is between Set-point + U22 and Set-point - U22;

The forced energized status will end when **Troom** arrives at Set-point + U22.

■ Stop forced heating

If now is forced heating, if R1 has been energized for U11 time, Keep [▼] depress for 5 seconds will stop forced heating.

● R1 Load Delay Protection

After power supplied, R1 could be energized after U10;

After R1 de-energized, it could be energized again after U10;

After R1 energized, it could be de-energized again after U11.

● Protecting Run When Sensor Fails (If U12 = 0, This Function Disabled)

When sensor fails, R1 will be energized and de-energized periodically.

For every 30 minutes, R1 will be energized for $U12 * 3$ minutes, de-energized for $(30 - U12 * 3)$ minutes.

For example: U12 = 2, if sensor fails, then R1 energized for $2 * 3 = 6$ minutes, de-energized for $30 - 2 * 3 = 24$ minutes, periodically.

● Defrost (Only for ZL-6220A+, only in Cooling Mode)

■ **Periodically defrost:** When R1 has been energized for U30, defrost for U31.

Note: After defrosted, start dripping water for U33. R1 keeps de-energized during dripping water.

■ **Manually force start / stop defrost**

During none-defrost status, keeping [▲] depressed for 7 seconds will start forced defrost. When defrosted, start dripping water;

When defrosting, keeping [▲] depressed for 7 seconds will stop defrost, and start dripping water.

■ **Dripping water after defrosted:** After defrosted, start dripping water for U33. R1 keeps de-energized during dripping water.

■ **Check the left time of defrost or dripping water**

When defrosting or dripping water, press [▲] will show the left time.

Attention: If the key is keeping depressed for 7 seconds, it will switch the defrost status.

● Buzzer Function

Every key press, there will be a short beep. Every confirmation key press, there will be a long beep. Every error operation, there will be three short beeps.

When there is failure, or external warning input: If U62 = 0, no buzzing warning. If U62 = 1, there will be continuous buzzing of warning.

The warning will stop, if press [P], or warning condition disappears.

● Alarm Output (Only for ZL-6230A+)

When there is failure, or external warning input, alarm output will be effective.

The alarm will stop, if press [P], or alarming condition disappears.

● Over Temperature Warning

When **Troom** \geq Set-point + U54, there will be high temperature warning if the following conditions meet;

When **Troom** \leq Set-point - U55, there will be low temperature warning if the following conditions meet:

If power just supplied, U53 has passed;

The **Troom** keeps the up condition for U52;

If just defrosted, U34 has passed (only for ZL-6220A+).

Note: High or low temperature warning does not affect the temperature control and defrost process. Just warning (display and buzzing warning, warning output (only for ZL-6230A+)) only.

● External Warning Input

NO: normal open. If open, no warning; if closed, warning.

NC: normal close. If closed, no warning; if open, warning.

Locked: Warning keeps after the external warning disappeared. Press [P] to stop warning.

Unlocked: Warning stops after the external warning disappeared.

Note: When there is external warning, the output(s) will be de-energized.

● **Sensor Calibration**

The sensor can be calibrated by U20.

● **Restore to Factory Default Settings**

Keep [P] and [▲] depressed simultaneously for 5 sec, there will be a beep, and “UnL” displays.
Press [▼] twice, there will be a beep, all settings will be restored to factory default settings.

Installation

1st: Insert into drilling hole

2nd: Clamp

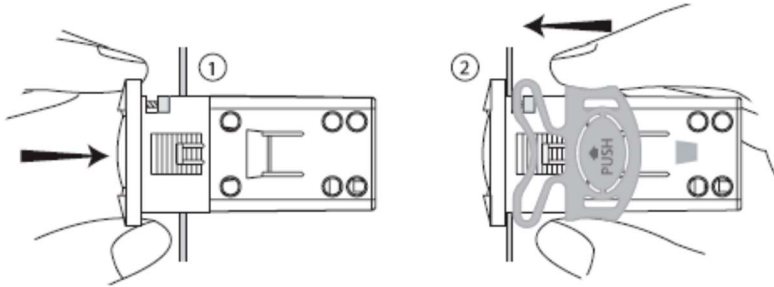

Attention

- Wiring work should be manipulated by certified technicians.
 - Wrong connection could damage the controller, and the loads. Power supply to terminal 5 and 6 to check the controller. If there is a multimeter, check the outputs, as well as input, by the help of settings.
 - Sensor and input signal wires should not be laid together with power supply wire, and even in same pipe.
 - Sensor wire is better as short as possible. Not wind the redundant length wire to electrical noise equipment.
 - The loads should be within the specification of the controller output driving ability. If using ac/dc module as load, or tungsten lamp, or motor, following the below requirements to avoid surging current damaging or shorten the life time of the controller outputs:
 - For ac/dc module as load, the rated current should be no more 1/10th of output specification **under pure resistance**.
 - For tungsten lamp as load, the rated current should be no more 1/15th of output specification **under pure resistance**.
 - For motor, the rate current should be no more 1/5th of output specification **under pure resistance**.
- For example: if drive a 1500W tungsten lamp with 7A (**pure resistance spec.**) relay, the **relay contactor will be burnt immediately**.
- Don't touch inside components;
 - Avoid installing controller in the following environment:
 - More wet than 90%RH, or easily dew;
 - Vibrating, or will be shocked;
 - Possible sprayed;
 - Under erosive air;
 - Under explosive air.

Electrical Wiring

